

# Installation Instructions

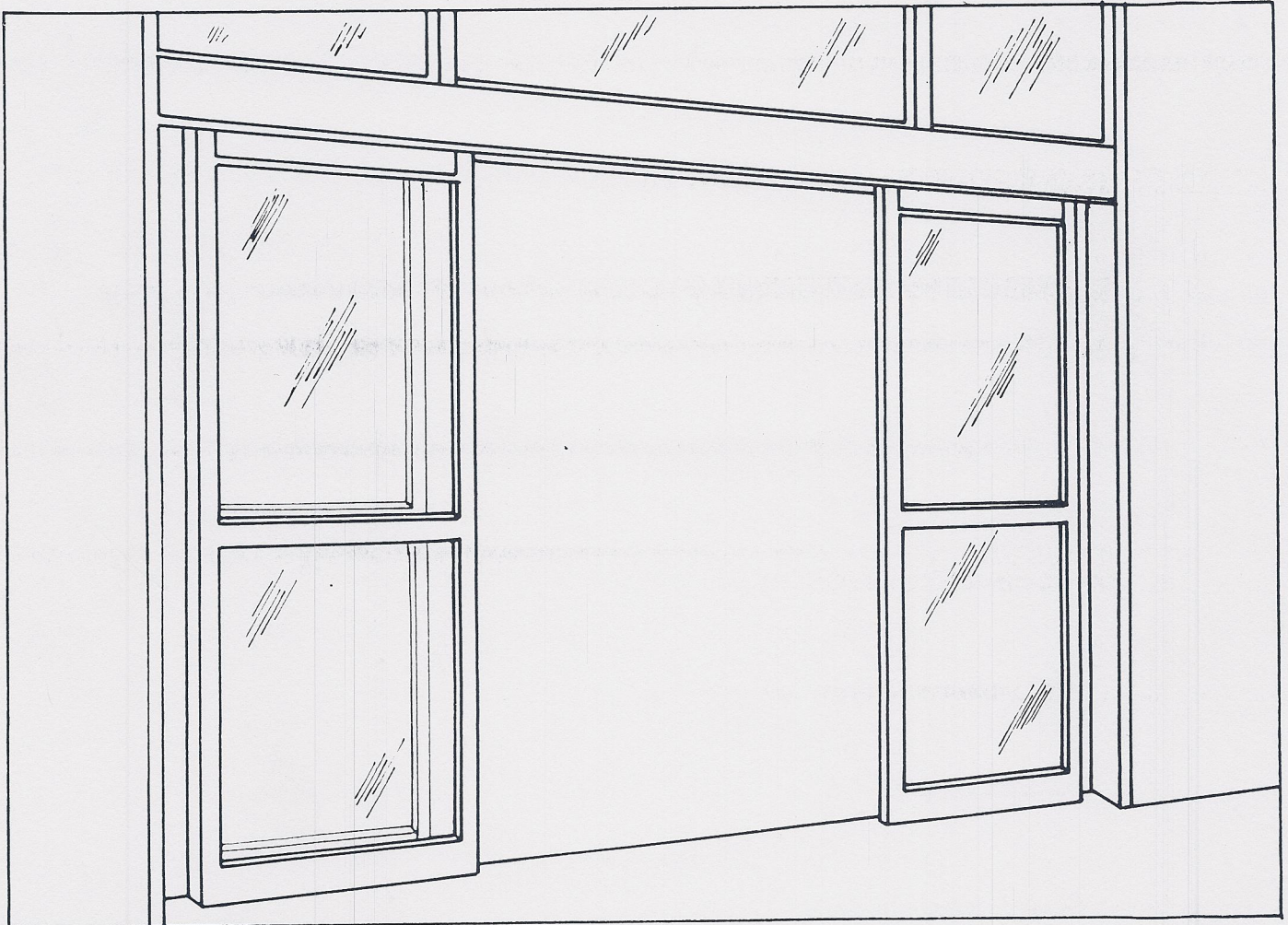

## Automatic Door Operators

### Series 1000 Electromechanical



**Keane Monroe - Opening Doors for People**



**Keane Monroe Corporation**

P. O. Box 5016  
Monroe, North Carolina 28111-5016  
Phone: 704/289-5581  
Telephone (800) 438-1937

## KEANE MONROE SERIES 1000 INSTALLATION INSTRUCTIONS

The Keane Monroe Series 1000 Electromechanical Sliding Entrance is pre-tested and pre-assembled to the greatest practical degree.

The operating mechanism has been completely installed in the Header, Doors prepared for hanging, and sub-assemblies completed. Basically, if all job conditions were ideal, it would be necessary for the installer to merely:

- 1) attach Side Jambs to the Header,
- 2) place and secure Side Jambs and Header Assembly in opening,
- 3) hang Doors and Sidelites,
- 4) connect Operator Mechanism to power source and activating devices (Sensors, Mats, etc.).

However, due to on-the-job conditions which vary from installation to installation, there are certain adjustments and assemblies which must be done by the installer. *Therefore, Keane Monroe urges you to carefully follow this instruction manual to avoid any unnecessary complications.*

## I. SHIPPING CARTONS & CONTENTS

Before beginning the installation of the Entranceway, you should check the number of shipping cartons and their contents to be sure you have received the entire shipment intact. Depending on the nature of the entranceway (i.e., Single, Bi-parting, Pocketed, etc.), the following shipping cartons should be received in your shipment: one (1) wooden crate, and one or more door cartons, each containing two (2) door leaves.

The wooden crate should contain the following: 1) a Header Assembly and Covers containing the pre-tested Drive Train, Operating Mechanism, Control and Door-Carrier Assembly, 2) Side Jambs, 3) the Bottom Guide System (See Section VI), 4) Transom Top and Mullions if required, and 5) installation accessories (See Figure B). Depending on your order, external switches such as Sensors may also be packed in the crate (See Figure A for an illustration of the crate contents).

FIGURE A:

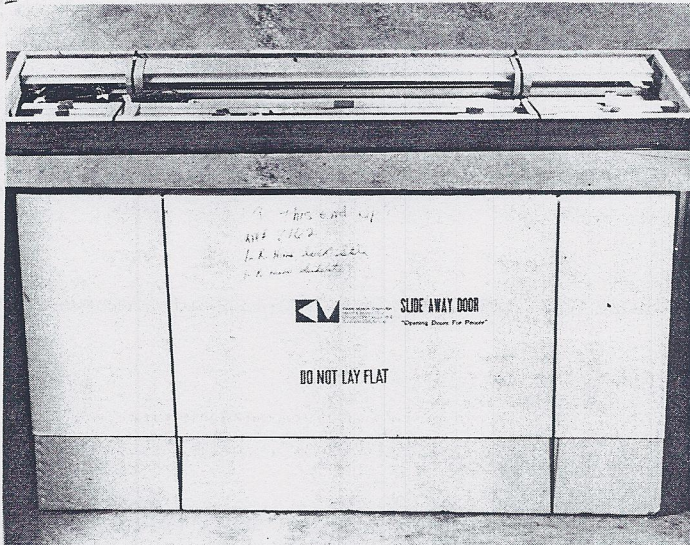

HEADER CRATE AND DOOR CARTON

FIGURE B:

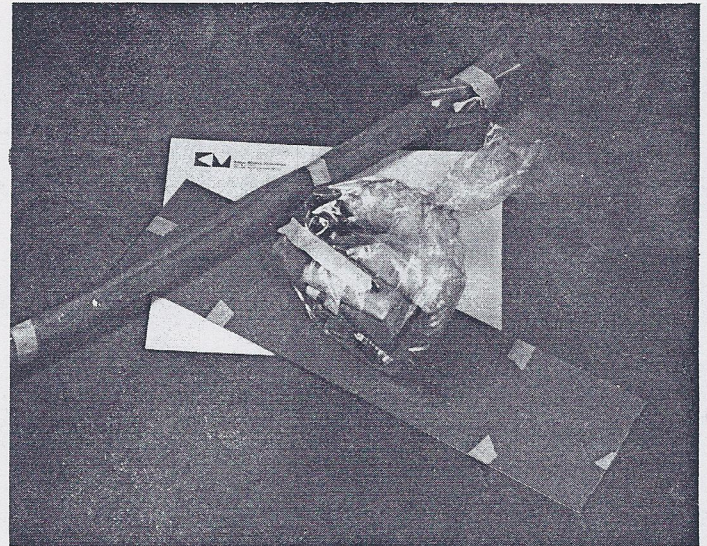

INSTALLATION ACCESSORIES

The corrugated cardboard door carton(s) contains two (2) unglazed Door Assemblies, as indicated on the outside of the carton(s). Also, each of the door panels comes with factory installed glass stop.

**NOTE:** Each crate and carton contains an Inspector's Check List. Retain this check list for future reference if needed.

## II. CHECK AND PREPARE OPENING

1. **IMPORTANT!** Before starting the entrance installation . . .

A. Be sure the opening has been properly prepared. It must be plumb and square. It must be sized in accordance with the appropriate 7000 Architectural Detail Sheets. If the floor is not level, re-prepare it. If it is not possible to correct an irregularity in the floor, establish the high point of the uneven threshold line, and raise the Side Jambs to meet the highest point (Figure C, next page). We cannot overemphasize the importance of a straight, level threshold line.

FIGURE C.

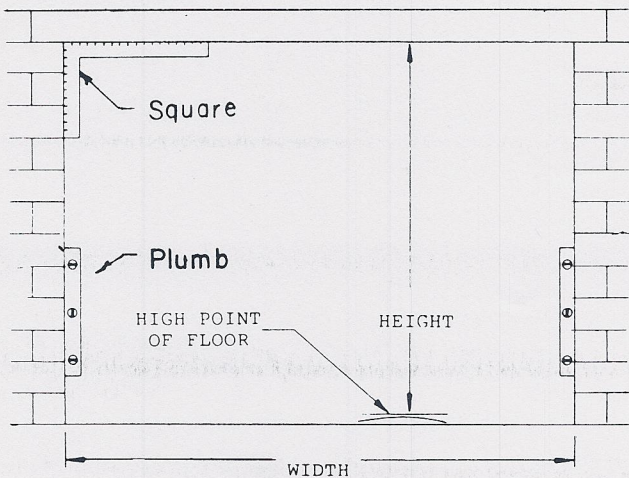

### PROPERLY PREPARED ENTRANCE OPENING

D. Prepare an adequate work area. Be sure the working surface is covered with cardboard or other material to protect the anodized aluminum surfaces.

2. Unpack the wooden crate first.
3. Remove the Side Jambs and set them in the opening to check the fit. (Note: Jambs are handed).
4. If opening is too small for Side Jambs:

A. For units without transom; re-check opening dimensions and re-prepare opening.

B. For units with transom; measure and cut top end of Side Jambs as required. Vertical mullions in transoms, 3/8" threaded tie rods and glass stops will also have to be cut accordingly.

### III. ASSEMBLY OF FRAME

1) Position the Side Jambs and Header on the horizontal work surface previously prepared, and assemble the components as they actually relate to each other (See Figure D).

2) Assembly of Units without Transom: The Side Jambs are supplied with angle brackets already attached (See Figure E). Attach the Side Jambs to the Header at the

angle bracket using 10-32 HEX Bolts and nuts in the header

3) Assembly of Units with Transom:

A) Place the Vertical Mullion(s) on the clip(s) of the Transom top.

B) The 3/8" threaded tie rod used to secure the Transom top is factory cut to accommodate a standard 3'6" Transom. If Vertical Mullions are cut to fit smaller opening, the rod must be cut to the length of the Mullion plus 2 1/4" to fit new dimensions.

C) Attach nut and lockwasher to one end of threaded rod.

FIGURE E

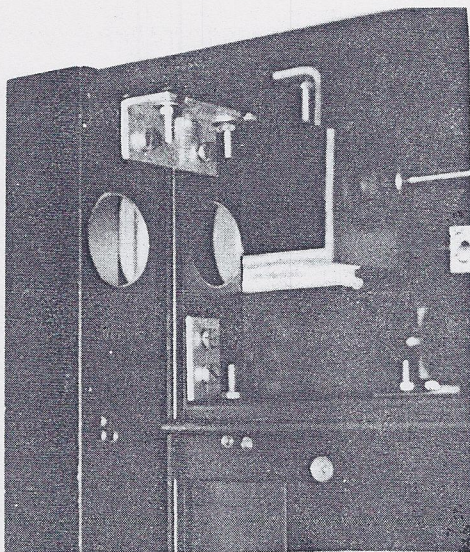

SIDE JAMB-HEADER BRACKET

**NOTE:** Take measurements at several points across the opening to insure a consistently level opening.

B. The unit has been made to receive electrical power on the motor side, so be sure the proper power preparation has been made. A separate circuit should be provided (120V-60Hz-15AMPS), and the power may be brought in through the jamb from the floor slab or from the ceiling.

C. Plan routing of wire for needed activating devices (Mats, Sensors, or others) before installing frame.

D) Insert the opposite end of the threaded rod through the Transom, through the Mullion and into the Header, being sure that the Mullion fits properly over the clips on the Header and Transom top.

E) Attach nut and lockwasher to the end of the threaded rod inside the Header.

F) Drill for No. 10 self-tapping screws on the inside top face of Side Jamb for the Transom top clips and attach the clips as shown. (Refer to Figure D).

G) Attach the Side Jamb to the Header and Transom top and tighten Tie Rods.

H) If the entranceway has a lintel, the Header must be supported with tie rods up through the Transom top which is anchored to the building structure.

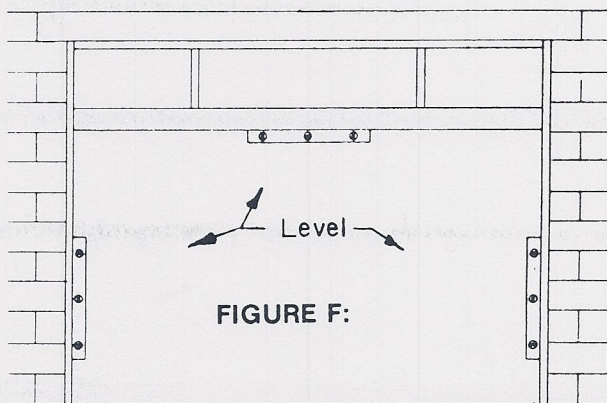
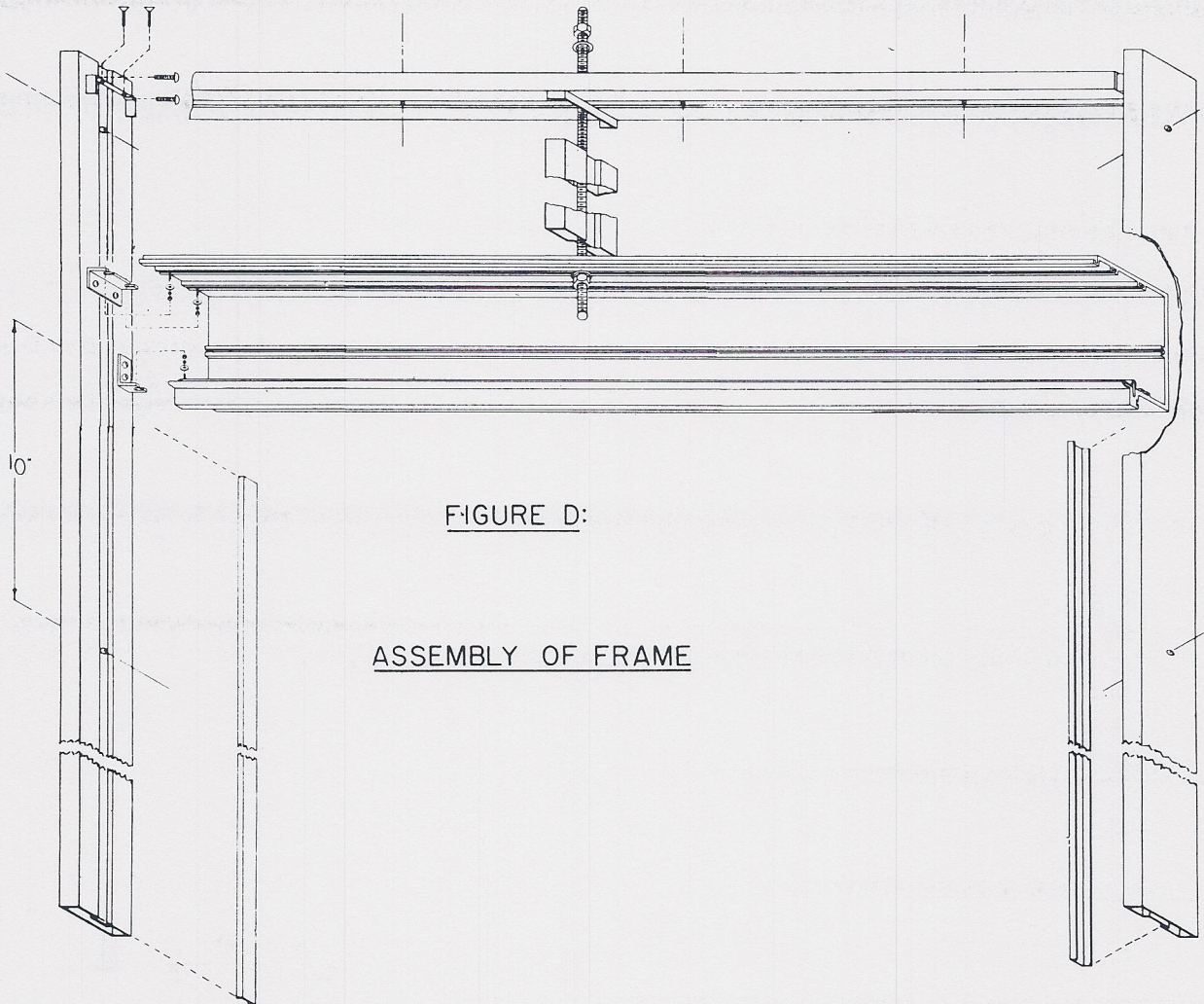

#### IV. INSTALLATION OF FRAME ASSEMBLY

1) When the assembly is complete, carefully raise the Entranceway unit into the prepared Door opening. Several times during the installation process, check that the Side Jamb and Header are plumb, level and square (See Figure F).

2) When frame assembly is properly placed in the opening, secure it to the opening. (Refer to Figure D).

**NOTE:** The Header or Transom Top must be anchored to the Lintel ever 3 to 4 feet.

**V. INSTALLATION OF THRESHOLD OR FLOOR TRIM PLATE**

If either a Threshold or Floor Trim Plate is used, it must be installed before installation of the bottom guide system.

**VI. INSTALLATION OF BOTTOM GUIDE SYSTEM**

There are two different bottom guide systems. Whichever bottom guide system is used, it must be level, straight, and properly located in the opening. A chalk line must be snapped between the Side Jambs to provide a straight reference line, even with the 1 3/4" inside face of the Side Jambs. This chalk line is used to locate the bottom guide system.

**FIGURE G:**

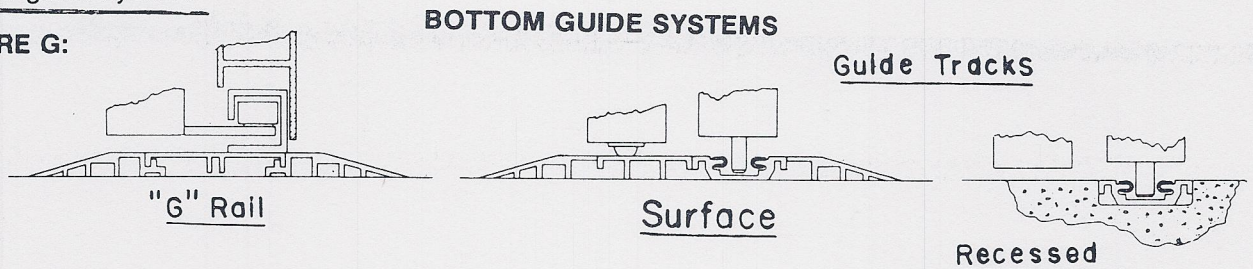

**A) G-Rail Bottom Guide System**

The accurate installation of the G-Rail System is critical, as is the installation of the guide tract. (See Figure H).

**FIGURE H:**

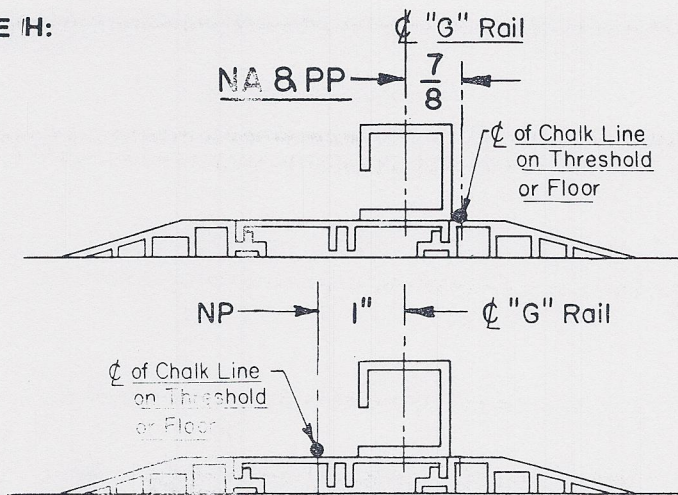

Mount the "G" rail leaving 1 3/8" space between the jamb and the end of the rail for service removal of the rollers.

INSTALLATION OF G-RAIL BOTTOM GUIDE SYSTEM

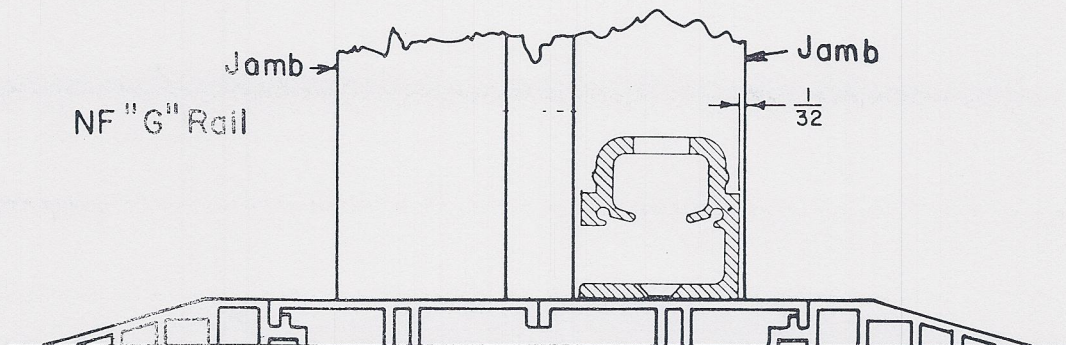

## B) Bottom Guide Track Systems

5

The bottom guide track system can be used for either recessed or surface application. (See Figure I).

**NOTE:** Recessed application requires special floor preparation as shown in Figure I.

**FIGURE I:**

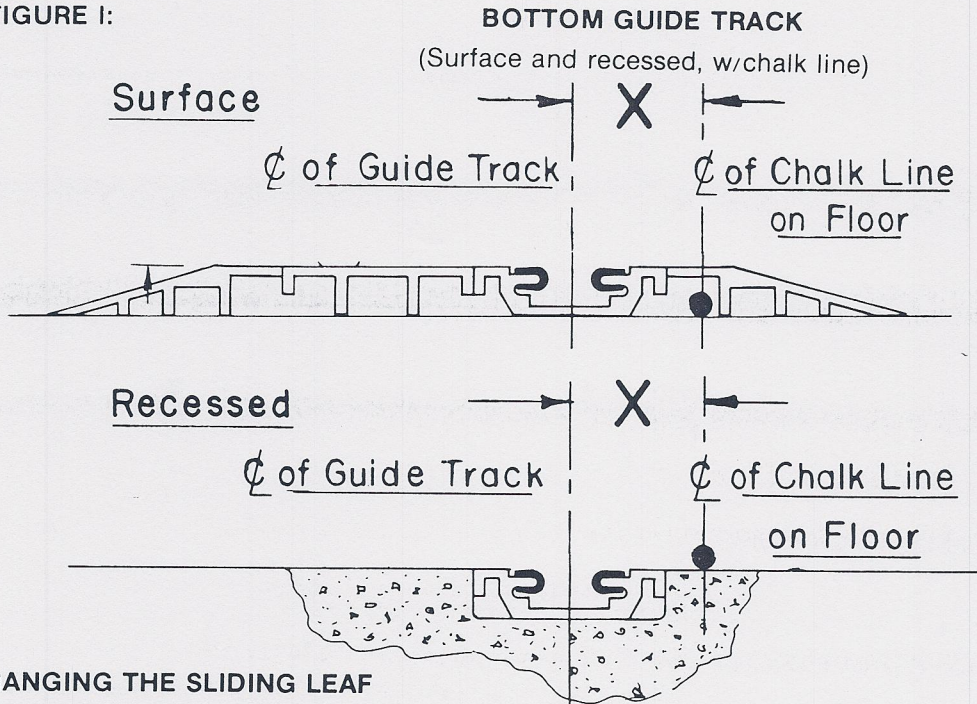

Type	X
NA, NF, PP	$3\frac{1}{4}$
NP	$1\frac{1}{4}$

## VII . HANGING THE SLIDING LEAF

- (a) Before hanging sliding door assemblies, remove nuts, lock washers and excentric cams from roller carrier assemblies, making sure not to lose anti-rise bracket.
- (b) Check sliding leaf to be sure it will paníc to the exterior of the opening.
- (c) Install door portion of bottom guide system in bottom of door as shown in Figure J.
- (d) Hang sliding door leaf assembly while simultaneously engaging bottom guide system. (See Figure K)  
Place the holes in the tee on top of the door over carrier studs, place adjusting cams on studs and attach lock washers and nut. (See Figure L)
- (e) Adjust door for height by turning cam nuts to attain proper level.

**FIGURE J:**

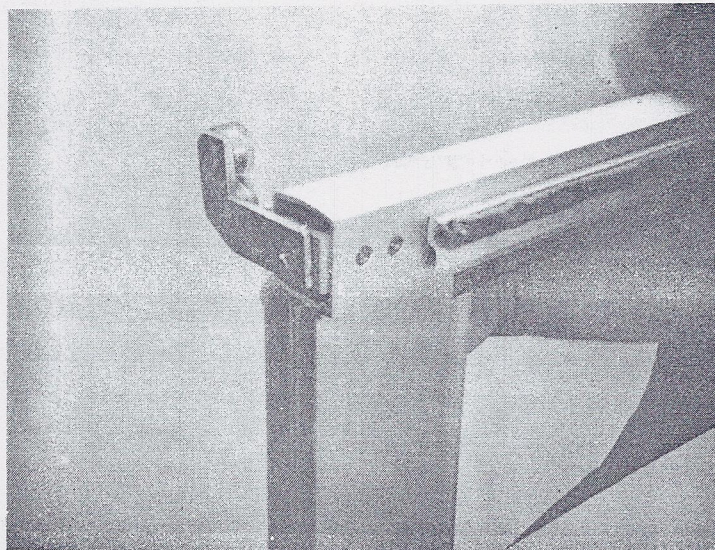

**DOOR PORTION OF BOTTOM GUIDE SYSTEM**

FIGURE K:

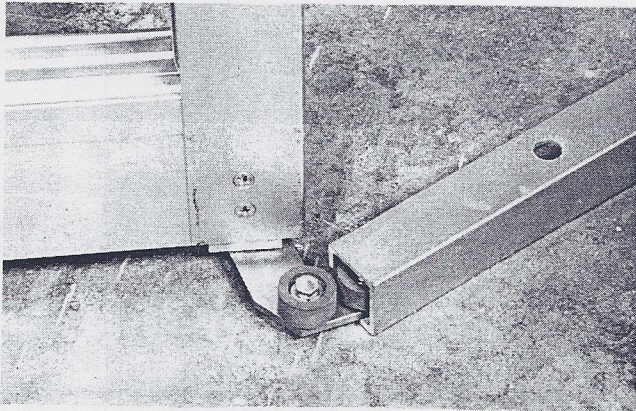
**ENGAGING BOTTOM GUIDE SYSTEM**

For Single Doors: Adjust the bottom door clearance throughout the full travel of the door as required and square the lock stile of the door with the Side Jamb. Then tighten the nuts on the Carrier Studs, keeping the stile square with the Jamb.

For Bi-Parting Doors: Adjust the locking leaf in the same manner as a single door. Adjust the remaining leaf by aligning it with the locking leaf. When the doors are in the closed position, there should be no gap between them.

FIGURE L:

**HEIGHT ADJUSTING CAMS**

FIGURE N:

**INSTALLATION OF DROP-IN PIN  
ON SWINGING PANEL**

## VIII. HANGING THE SIDELITES

A) Fixed Panels — install fixed panels over the G-Rail and fasten the panel to the Side Jamb and Header using the pre-drilled holes and the screws furnished with the installation accessories.

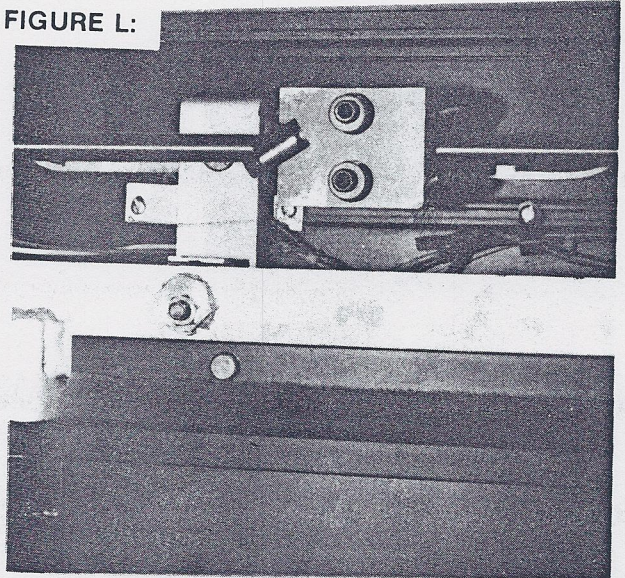
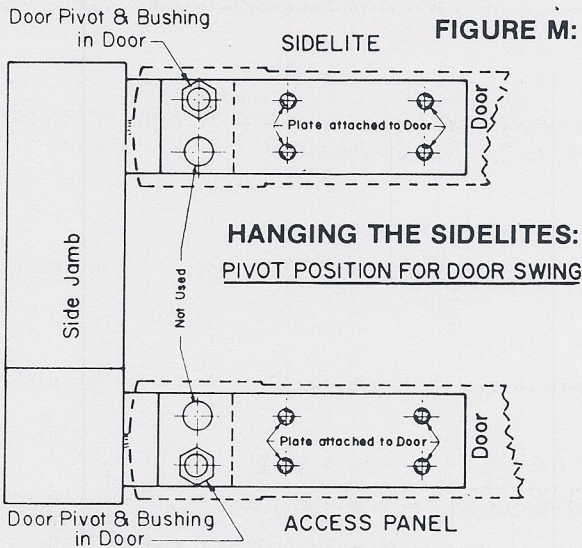
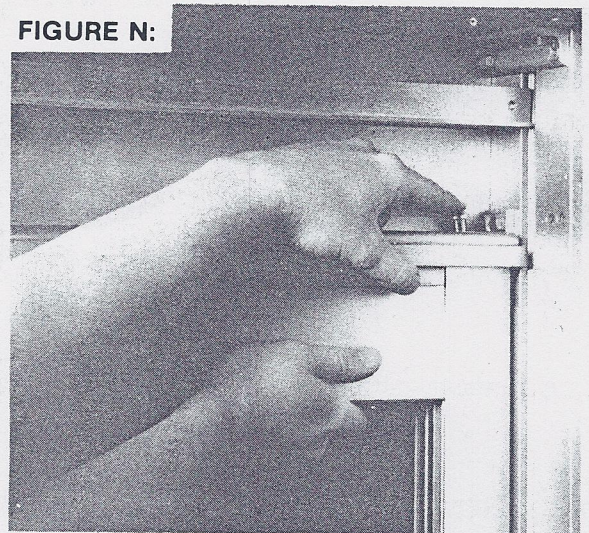
B) Swinging Panels — refer to Figure M, for placement and proper hand of the Swinging panel.

**INSTALLATION** — Place the Swinging Panel on the Bottom Pivot Pin. Slide the panel under the Header aligning the bushing in the Header with the bushing in the top pivot plate of the panel. Push the Pivot Pin down from inside the Header through both bushings. Slide the Pivot Pin Retainer over the head of the Pin and tighten the nut.



## ANTI-RISE ADJUSTMENT

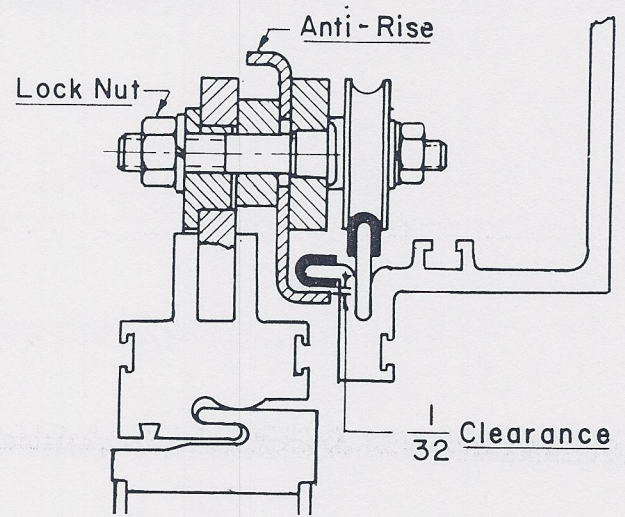
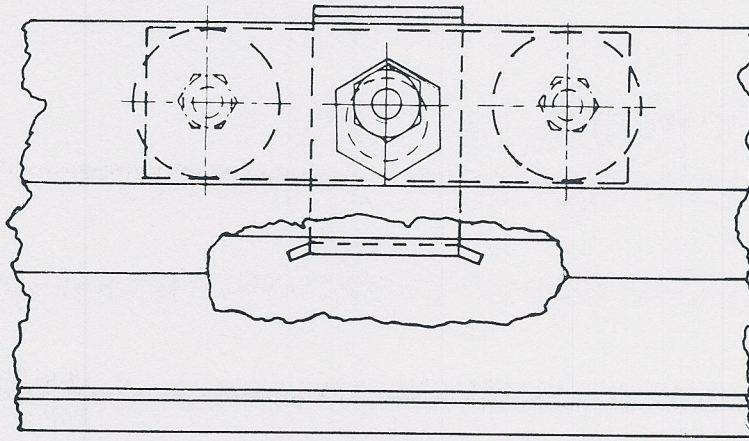

To Set Anti-rise Plates (two per sliding door):

- 1) Loosen but do not remove the locking nut.
- 2) Using a flat screw driver, pull anti-rise plate up to bottom lip of header. Using driver handle tap plate down approximately 1/64 inch.
- 3) Retighten the lock nut.
- 4) Move the door manually through its full travel and check for drag on anti-rise plate. Reset lower if drag is present.

## PANIC BREAKAWAY CUTOFF SWITCHES (USED WITH FIXED PANELS ONLY)

To prevent them from being broken in shipment the panic breakaway cutoff switches for fixed sidelites are included in the installation supplies. They are installed by feeding the wires down through the stile of the fixed panel and through the cutouts. The wire terminals are plugged into the switch "common" and "normally closed" terminals of the switch. The switch/bracket is then attached to the fixed panel with the four screws provided, and when properly installed should be held in by the top rail of the sliding door as shown below.

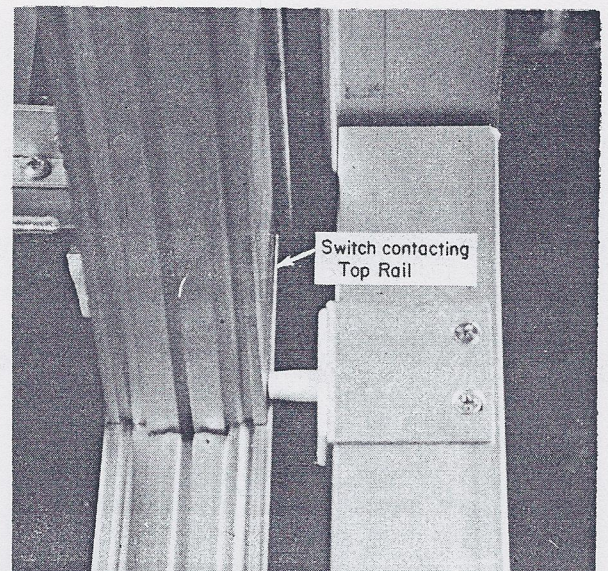
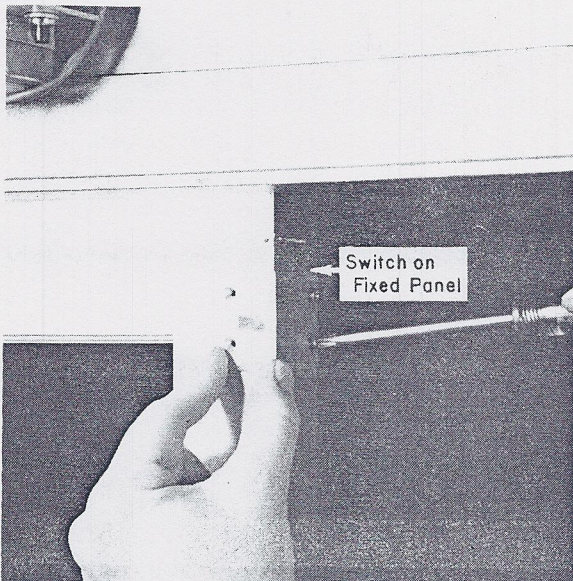
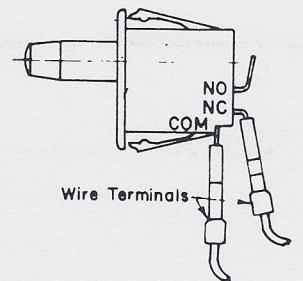

## IX. PLACEMENT OF TWO-POINT LOCK STRIKE

FIGURE O:

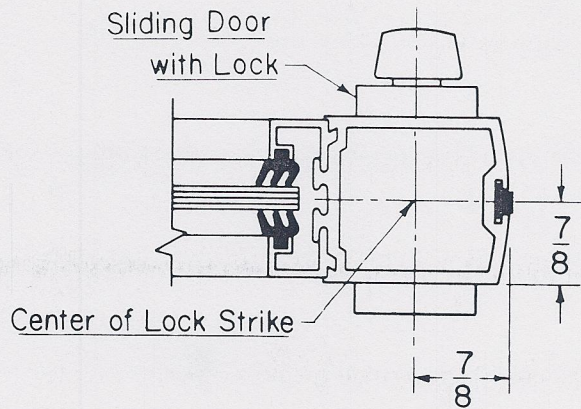

Correct placement of the two point lock strike is critical.  
Follow the dimensions shown in Figure O.

## X. ADJUSTING SLIDING DOOR LEAF PRELOAD

When the Sliding Door Leaf is glazed, preload adjustment of the door support may be necessary for proper operation of the Panic Catch Mechanism.

- A) Break the Sliding Door into the panic configuration and attempt to close the door. If it is not aligned properly, readjust the preload.
- B) Loosen the two Phillips Screws on the heel of the Sliding Door Leaf, (See Figure Q).
- C) Adjust the Socket Head Screw thru the center hold until the Panic Catch Mechanism is properly aligned.
- D) Retighten the two Phillips Screws.

FIGURE Q:

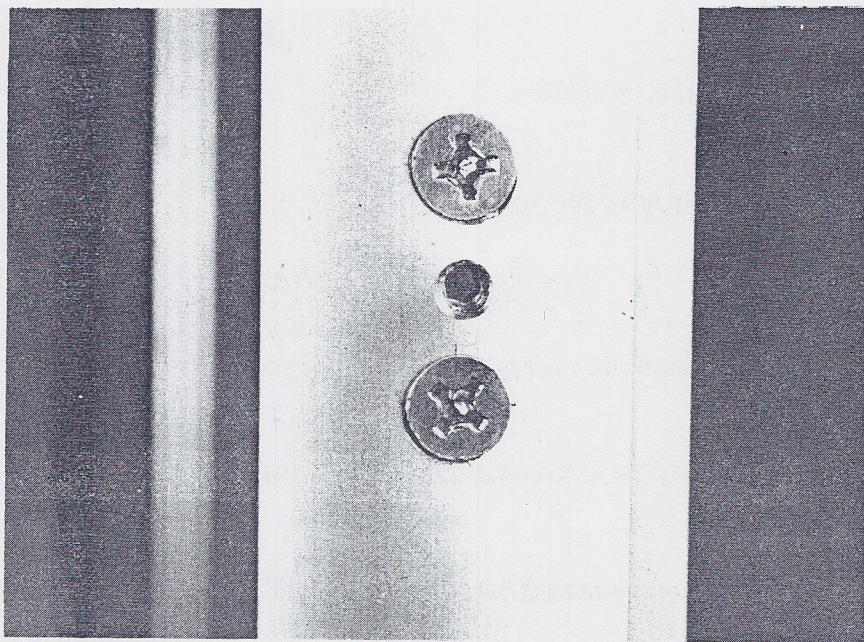

## XI. FINAL MECHANICAL CHECK

Operate all doors manually for both slide and swing including panic swing in both open and close slide configuration.

## 1000 ELECTRICAL INSTRUCTIONS

## I. MAIN POWER INSTALLATION

- 1) Insert Off/On switch assembly thru 1 1/2 hole in side jamb and thru 1/2 inch dia hole provided in narrow side of side jamb. Secure with nut provided.
- 2) Bring 120 Volt 60 HZ 15 AMP service through side jamb on duplex fixture side of header and connect inside of duplex fixture handy box. (See Figure R)

Note: If separate transformers are used to power sensors and or safety beams, they may be plugged into duplex receptacle, using low profile angle plug.

FIGURE R:

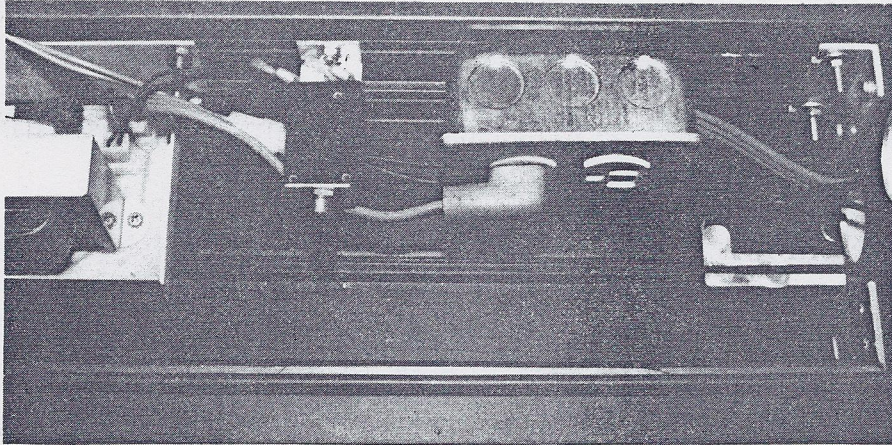

MAIN POWER CONNECTION

## II. MAT INSTALLATION

1. Run door activating patch cord down channel provided in Side Jamb to threshold area.

A floor mat should be centered in the clear door opening. The width of the exposed area of the mat (excluding trim) shall not be less than 10 inches of the width of the clear opening. (See ANSI Standards ANSI A156-10-1985 for more information.) The threshold should be centered under the sliding door leaf. The mat lead wires should run under the threshold to the Side Jamb with no joints or splices under the threshold. The door activating control circuit is a two wire system. One wire from each mat should be connected to one each of the activating patch cord going up to the Side Jamb to the control. When installing the mat and threshold, care must be exercised so that the threshold or the attachment screws do not interfere with the mat lead wires.

FIGURE S:

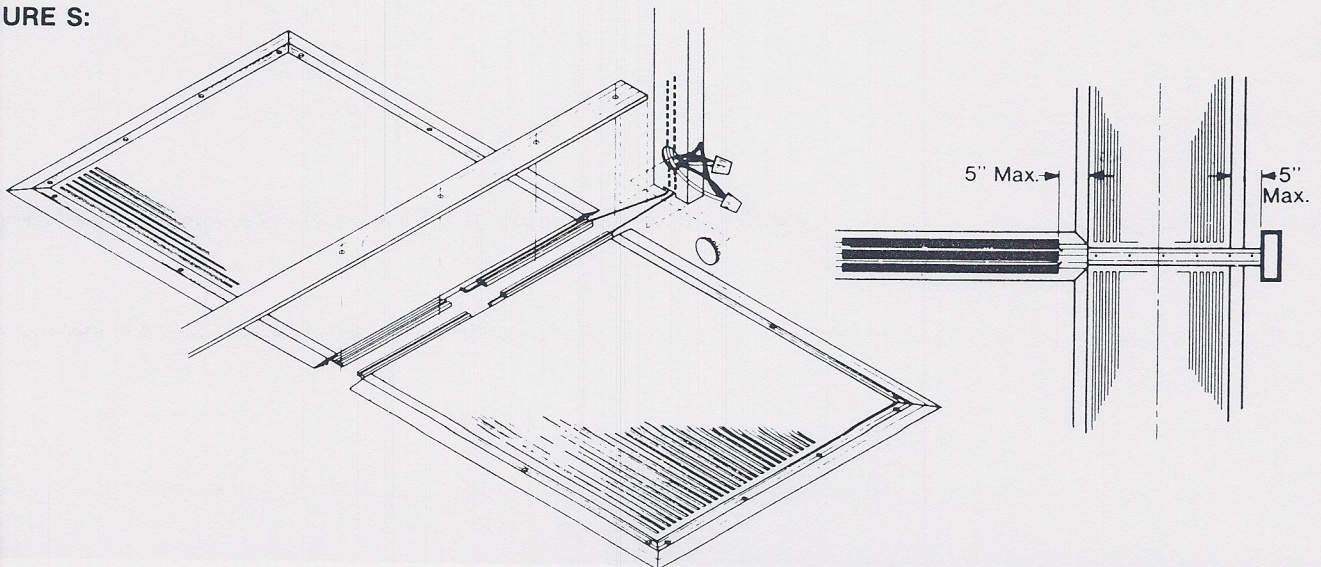

### III. WIRING OF DOOR OPENING DEVICES

The 1000 Slider may be activated with mats, sensors or any normally open, momentary contact device by connecting to the activating circuit through the eight foot patch cord connected to plug and socket housing labeled "I".

**FIGURE T:**

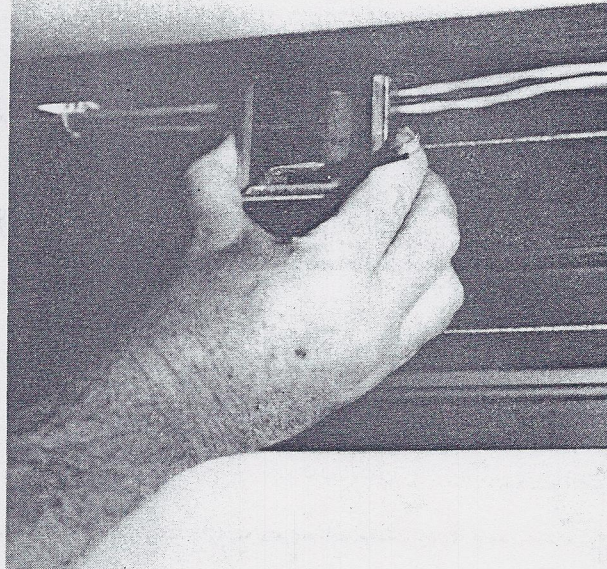

### IV. SENSOR

After sensor(s) are securely mounted, provisions must be made by the installer to route power and activating harness from sensor(s) to door activating cable (plug "I") and secondary side of supply transformer. (See Wiring Diagram WD-170, Page 13 for proper connection.)

Location of Sensor and Safety Beam Transformer

Mount transformer as close to duplex handy box as possible. Be sure transformer and wiring do not interfere with cover, drive mechanism or sliding doors.

### V. SAFETY HOLD BEAM INSTALLATION

Cutouts are prepared in side jambs and access panels to receive safety hold beams when furnished by Keane Monroe. For installation of safety hold beams, the following items must be considered:

1. Four conductor stranded wire is used to wire detector to activating circuit (Plug "I") and 24v. side of supply transformer.
2. Two conductor stranded wire is used to wire emitter to 24v side of supply transformer. See Wiring Diagram WD-170 for complete hook-up of emitter and detector.

NOTE: Route and secure all wires so as not to interfere with normal operation of the door. (See following illustrations for single and bi-part applications.)

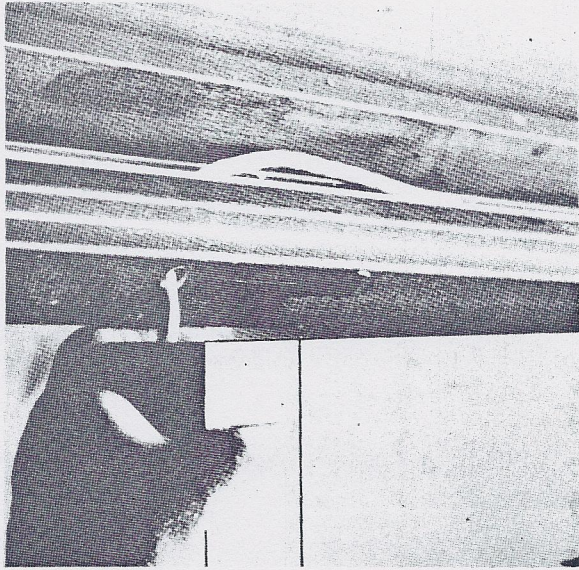

**WIRE ROUTING FIXED PANEL**

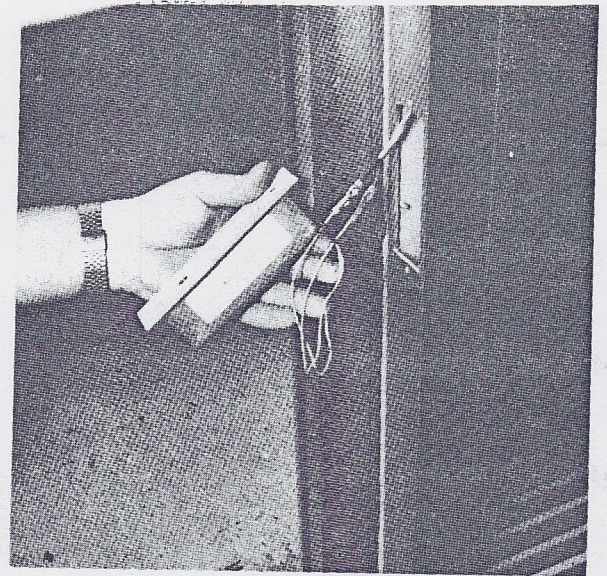

**EMITTER INSTALLATION**

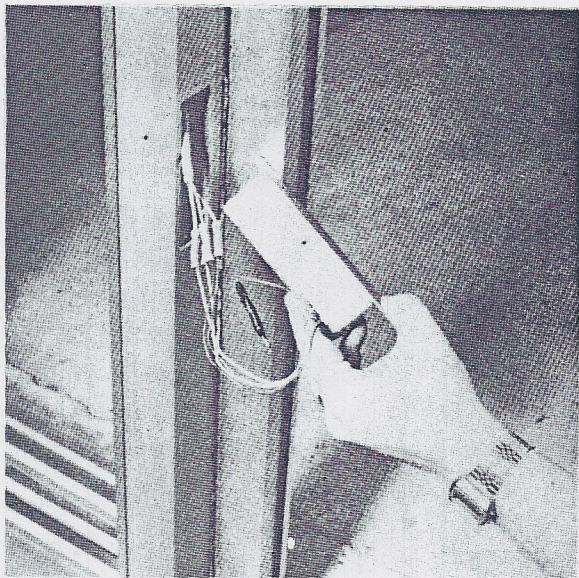

**DETECTOR INSTALLATION**

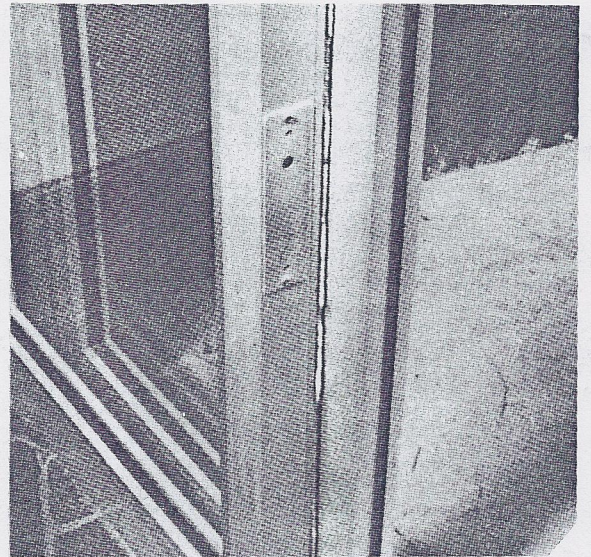

**FINISHED INSTALLATION**

NOTE: On breakaway panel(s), wire must be routed through top rail of door to enter header at pivot; enough slack should be allowed to permit safe opening of door.

IMPORTANT: Upon completion, move door slowly by hand from the closed position to full open position to assure all wires are securely fastened with clamps, ties etc., and in position to clear the moving mechanical mechanism — i.e. carrier assembly, chain and cable, etc.

## VI. LATCH CHECK, BACK CHECK AND SPEED ADJUSTMENT

A Special Channel extruded into the header allows infinite adjustment in the placement of the four limit switches that control the motor cut off latch and opening check of the doors (see below). By loosening the two Philips head screws, each switch assembly can be moved and locked in place according to the needs of the individual application. Coupled with the separately selectable speeds for opening, closing and checking located in the main power transformer this provides the opportunity to adjust the control of the doors to fit any situation.

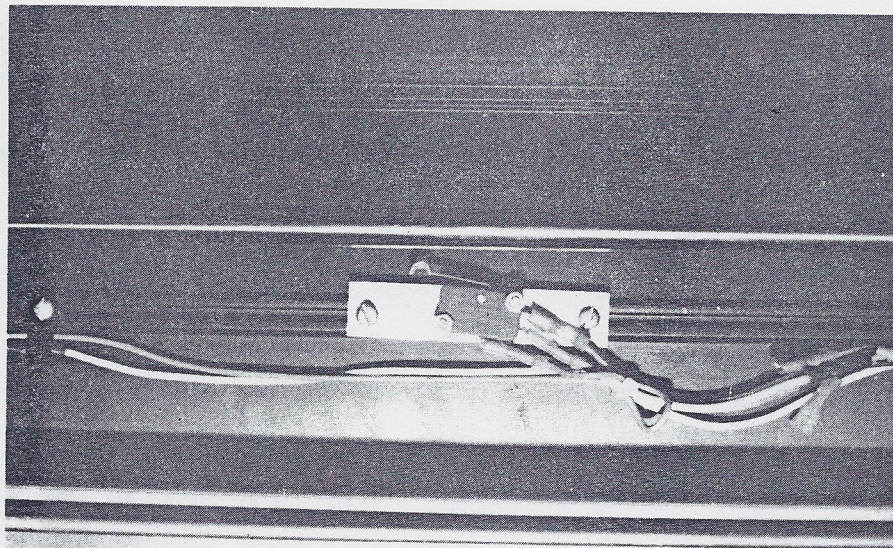

## VII. ADJUSTING THE OPERATOR

- (1) Operate door normally to be sure there are no restrictions.
- (2) Check each of the four limit switches to see if working properly by listening for the click. Full open cut off switch should trip approximately 2 inches before door encounters bumper. Close cut off limit switch must be adjusted to trip just before full closed.
- (3) Set circuit breaker by depressing black plunger and turn on toggle switch in jamb. Select door speeds required by moving slide switches located in control box.
- (4) Activate door. Limit switches are set at factory for door check position. Check position can be advanced or decreased by repositioning switch assembly in switch track.
- (5) Closing force to prevent door from closing should not exceed 30 pounds. Using a spring scale, check the forces at several points in the closing cycle. The scale reading should not exceed 30 lbs. To reduce closing force, turn the allen head screws on the front of linear actuator assembly counter clockwise. To increase force, turn screws clockwise.

### Decal Application (Per ANSI-A156.10-1985)

A set of decals are included with each sliding entrance package. They are to be applied horizontally adjacent to the lock stile on a centerline 36" (914 m m) minimum and 60" (1524 m m) maximum from the floor.

**VIII. INSTRUCTIONS TO OWNER**

Once installation of sliding entrance package is complete, we suggest you meet with the owner to acquaint him with the operation of the unit and preventative maintenance requirements.

Items to be covered but not limited to are:

- (a) Location of On/Off switch.
- (b) Activating device, (mat, sensor, push plate switch, etc.)
- (c) Instruct owner in procedure to lock and unlock unit.
- (d) Review Daily Check List for owner.
- (3) All literature shipped with door should be presented to owner at this meeting.
- (e) All literature shipped with door should be presented to owner at this meeting.

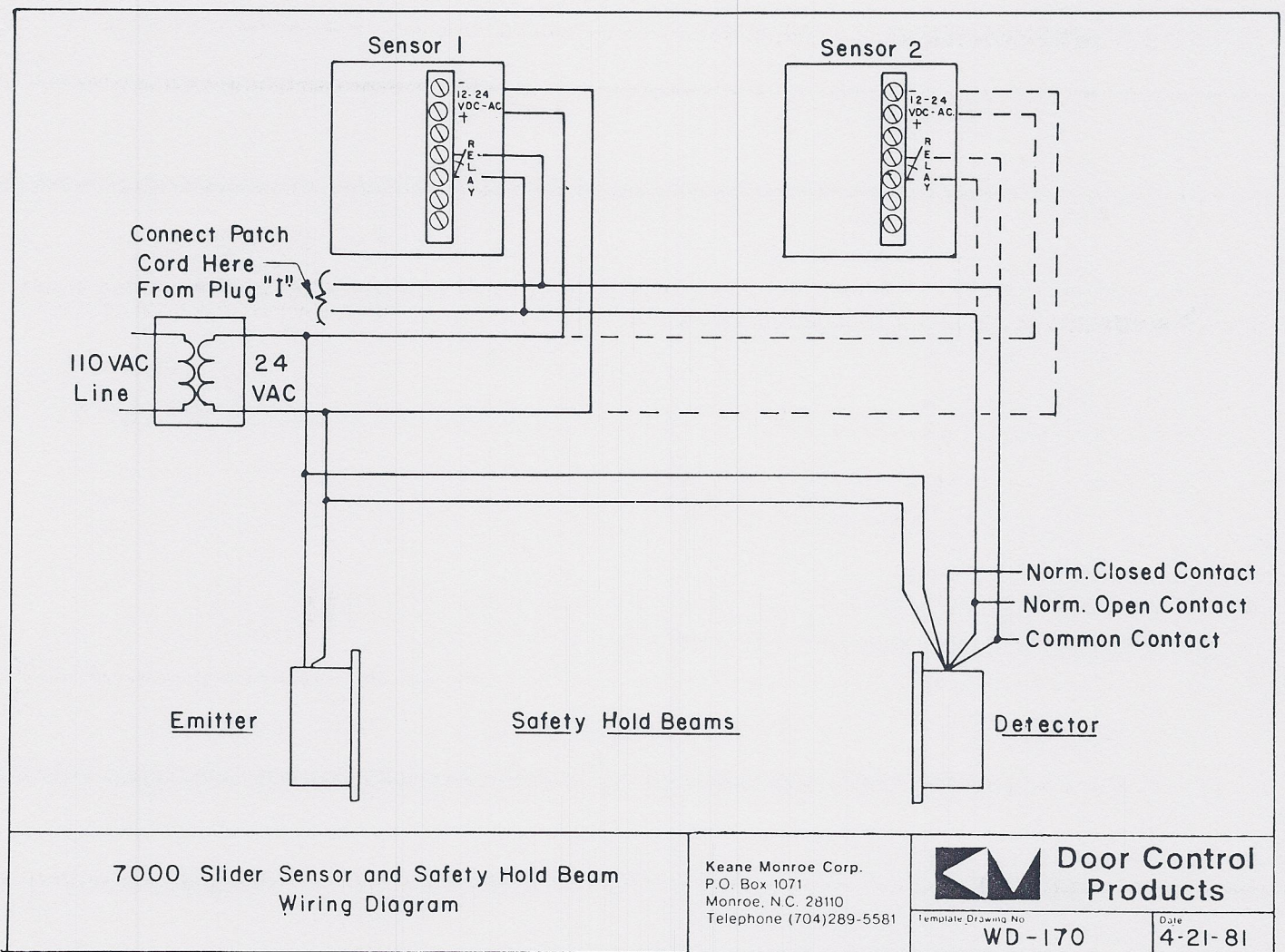

7000 Slider Sensor and Safety Hold Beam  
Wiring Diagram

Keane Monroe Corp.  
P.O. Box 1071  
Monroe, N.C. 28110  
Telephone (704)289-5581



**Door Control  
Products**

Template Drawing No  
**WD-170**

Date  
**4-21-81**

