

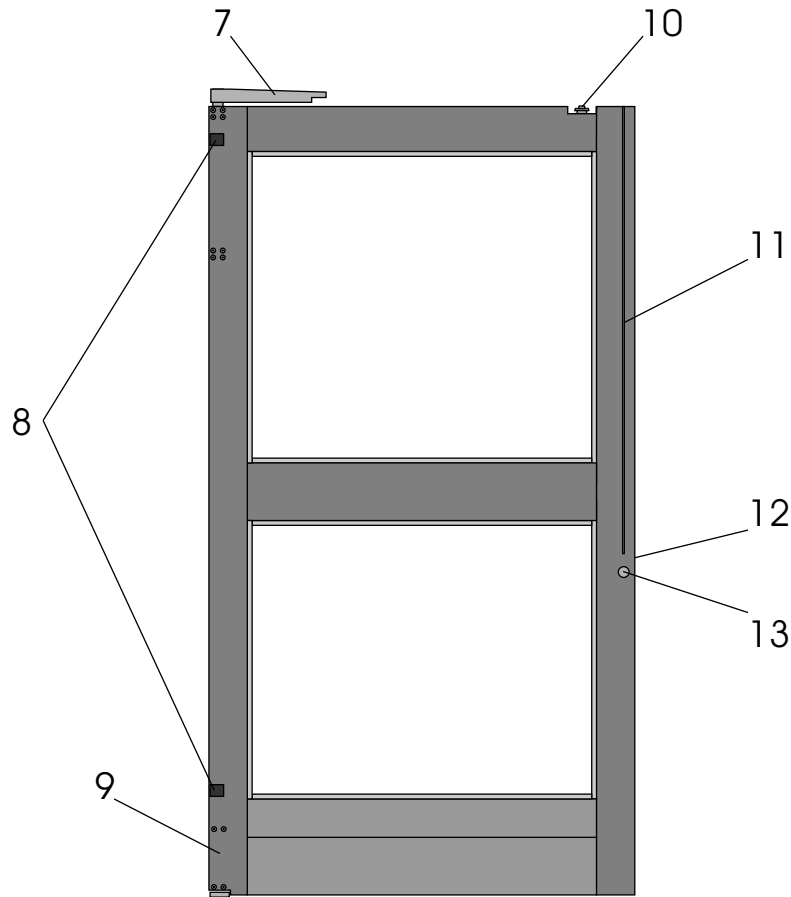





FULL BREAKOUT H.D. STYLE LEAF HARDWARE

R.H. ACTIVE SHOWN L.H. OPPOSITE

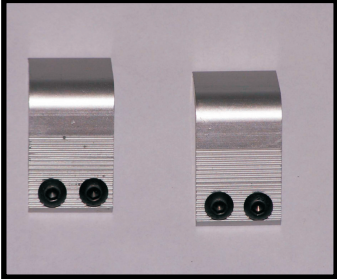
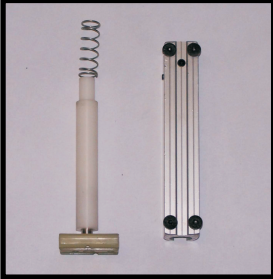
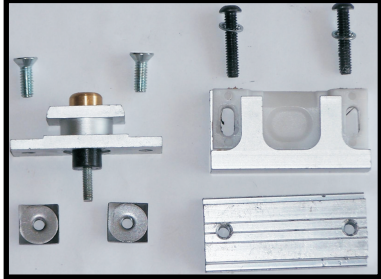

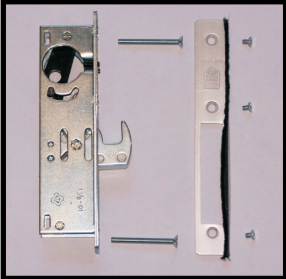
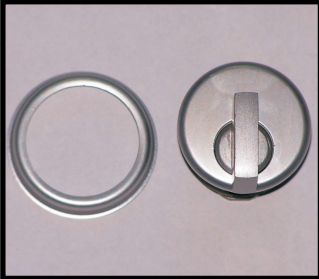
NOTE: PICTURES NOT TO SCALE

 <p>7 BREAKOUT PIVOT ARM 350-060</p>	 <p>8 Interlocks 35x-016</p>	 <p>9 FULL BREAKOUT BOTTOM PIVOT ASSY. 350-003B</p>	 <p>10 BALL CATCH ASSEMBLY ACTIVE LEAF 35x-002</p>
 <p>11 TOP LOCK ROD ASSY 350-065-01 or -02</p>	 <p>12 HOOK LOCK ASSY 35x-039</p>	 <p>13_{Interior} THUMB TURN CYLINDER 35x-031</p>	 <p>13_{Exterior} TEMPORARY LOCK CYLINDER 35x-030KA</p>

x= FINISH 1-MILL 2-CLEAR 3-BRONZE REPLACE "x" WITH COLOR NUMBER
LENGTH= LENGTH NEEDED IN INCH TO NEAREST UPWARD FOOT



SLM 12