

COMMANDER I (RBI)
SELECTSCAN
PATHFINDER
(IRD)
ROC 1B II

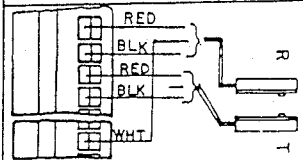
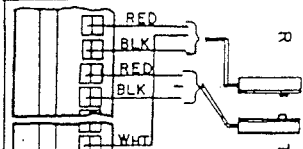
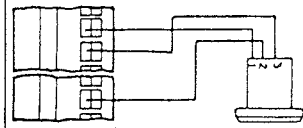
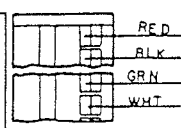
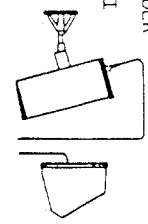

PHC
FS NO.2 OFF

PHM
FS NO.2 OFF

PHO
FS NO.2 ON

* ONLY 1/4" PHOTOCELLS
TRANSMITTERS
■ JUMPER S REQ ON TB-2
SEE MANUAL FS NO.2

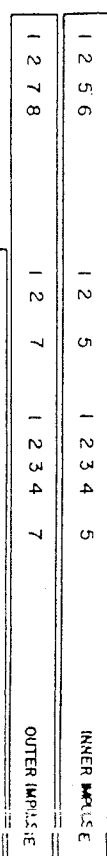

2+3 = 36VAC
4+6 = 15VAC

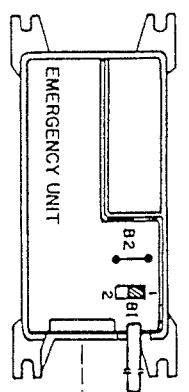
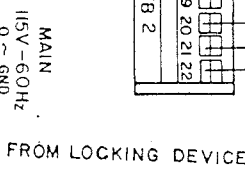
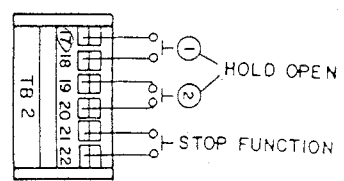
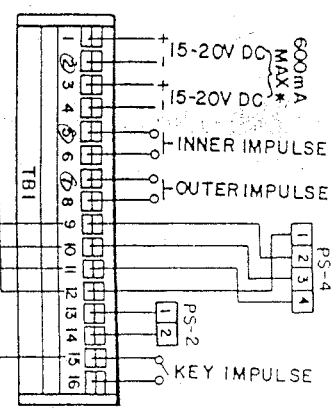

FROM REVOLUTION COUNTER

FROM MOTOR

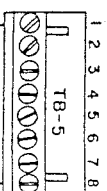
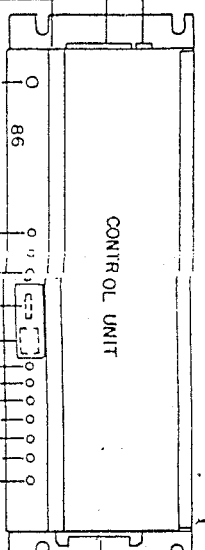

PUSH BUTTON

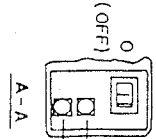

(ON) MAIN SWITCH
F1 MAIN FUSE (4A T) 115V
F2 CONTROL FUSE (1.5T)

CONNECTION BLOCK

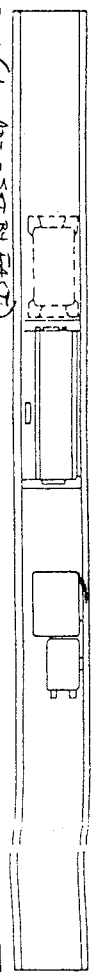

Auto Reverse (Non-Abs. - Set by FACT)
MON - LIGHT EMITTING DIODE ILLUMINATED WHEN VOLTAGE IS APPLIED TO THE MOTOR
ERR - LED FOR ERROR INDICATION
ACC - ACCELERATION
RES - RESET OF THE COMPUTER

HSO - HIGH SPEED OPENING
HSC - HIGH SPEED CLOSING
LS - LOW SPEED OPENING AND CLOSING
LO - LOW SPEED DISTANCE
PO - PARTIAL OPENING
T - MEASURING UNIN TIME

CONNECTION DWG

86

Bosom
1117WIN GIVERS DRIVE
EAST WINGBORO, N.J.
609-443-5000 085520

Evans are common